

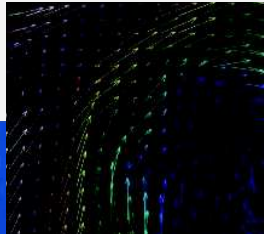

Multipulse Lasers

Nd:YAG Q-Switched lasers systems



PIV: Particle Image Velocimetry
A non-intrusive optical measurement technique to measure fluid or particle velocity vectors at many points in a flow field simultaneously. Quantity and quality measurements are usually made in "Planar slices" of the flow field.

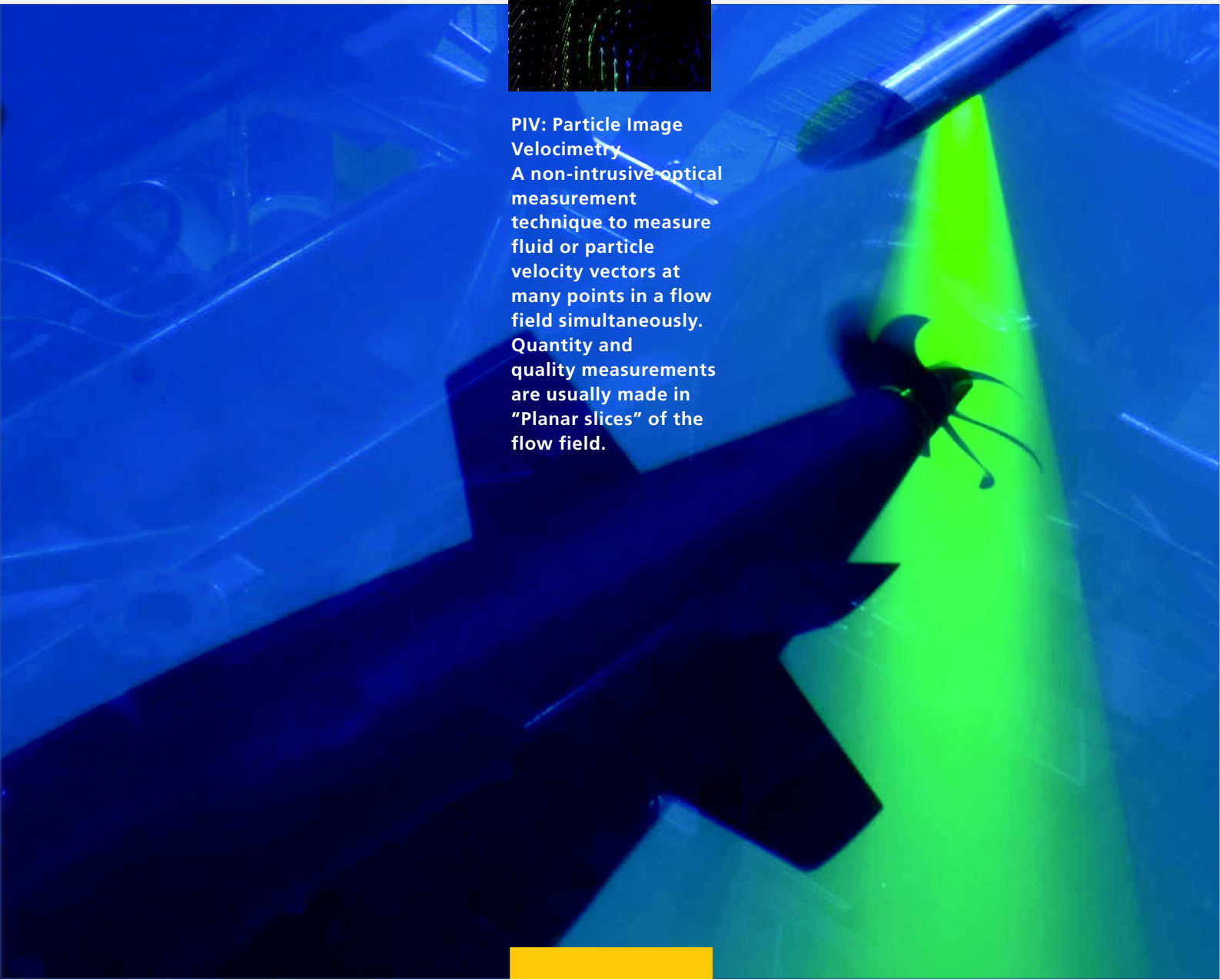

A wide range of multipulse systems

Quantel offers a full range of dual Q-Switched pulsed Nd: YAG laser systems to meet virtually all the needs of today's research and industrial community.

The Twins BSL lasers from Quantel comprise two laser heads with beam combining optics, second harmonic generation and wavelength separation assemblies in a third module. Each system module is securely mounted on a rigid base plate, factory aligned and locked in place. In this way, maximum output energy per pulse is obtained whatever the temporal separation. A fourth harmonic generator is available for those who want more flexibility of both PIV and LIF (Laser Induced Fluorescence) measurements. The spatial overlapping of the two green beams is included in the 1 year warranty.

Insensitive to Misalignment

BSL's Compact Folded Resonator (CFR) laser heads are all machined from a single block of aircraft grade aluminium in an I-beam configuration to ensure maximum stiffness, stability, and resistance to warping. All optics are pinned in place and, once aligned, are extremely resistant to misalignment.

A folded resonator configuration is utilized that places the output coupler and the rear mirror in the same plane. Any slight movement due to environmental conditions is traced identically in both mirrors. Alignment is assured.

Comprehensively Tested

Each Twins BSL laser system is temperature cycled from 5 to 60°C and tested prior to shipment. This ensures that optical components are seated and each unit performs to specifications over a wide operating range.

The lasers have also undergone extensive shock and vibration testing to prove the integrity of their design and their stability under harsh environmental conditions.

Easy Lamp Change

All BSL lasers feature quick and easy flashlamp changing by the user. This requires no realignment of the resonator and can be accomplished in seconds.

User Friendly and Portable

The Integrated Cooling and Electronic (ICE450) units are small and portable. Closed loop water-to-air cooling is provided as standard, avoiding the need for an external water supply. A pair of 15kg (30lbs) miniaturized ICE's powers all the Twins BSL models. An ethylene glycol filled cooling system is available as an option for use at low temperatures. The remote control box and the TTL I/O are made for intuitive,

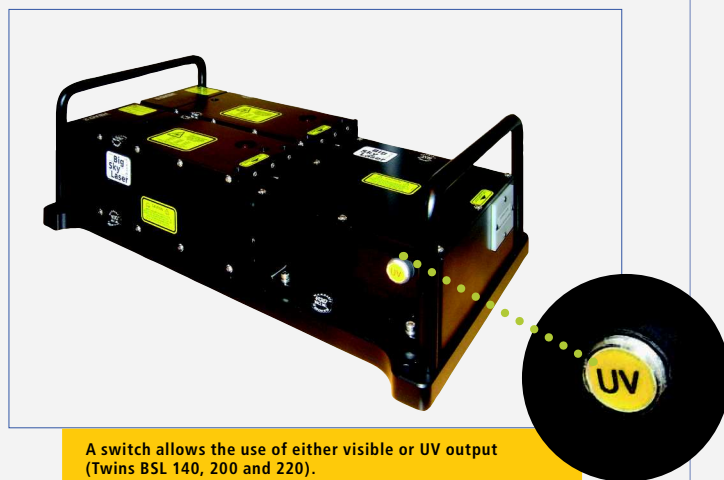

A switch allows the use of either visible or UV output (Twins BSL 140, 200 and 220).

logical and easy operation; synchronization is a breeze. On request, 2 electronics and 1 cooling group can be packaged in a single housing.

Quick Disconnect Head

The systems are all designed for maximum ease of operation and portability. The laser head assembly can be removed from its cabling via quick disconnects. The coolant lines, self-seal, allow the operator to easily transport the laser head assembly and cooling/electronics units separately without the need for refill later.

The focus at Quantel is on taking the lasers out of the laboratory and into "real world" applications. Robust, portable, convenient and in a small package – this is the Twins BSL.

Optional 4th Harmonic Option

When the user wants to combine PIV and Laser Induced Fluorescence experiments, the Twins BSL models can be delivered with a fourth harmonic generator.

This thermally controlled non linear crystal is factory set-up in the combining module together with relevant separation optics.

An electric switch located on the side of this module allows the use of either green or UV output by changing the phase matching condition of the UV crystal.

Built-in Attenuator

An easy access to the wave plate prior to the doubler allows output energy attenuation.



The range includes:

- The compact, environmentally hardened Twins BSL series (from Big Sky Laser products range)
- Quantel innovative Twins series of low divergence, transportable scientific lasers
- Quantel YG series of high-end custom laboratory lasers delivering up to 1.2 joules per pulse in the green

For experiments requiring high energy, low divergence and modularity Quantel offers its Brilliant series of compact, air-cooled pulsed Nd:YAG oscillators. They represent the state of the art in laser design and form the basis of the Twins and Twins B systems.

High Performance

The Brilliant series of Nd:YAG oscillators features exceptional beam quality, pointing stability, energy stability, and timing jitter properties. This makes them ideally suited to PIV applications where uniform illumination of a flow field, with accurate timing, will lead to the best measurement results.



Unique Design

These key laser performance features are the result of the unique design of the Brilliant oscillator, from the pump chamber and the thermally stabilized resonator to the carefully engineered power supply and cooling system.

Stable Construction

To make a Twins system, two independent Brilliant oscillators are mounted together securely on a very rigid "U" section optical bench with the beam-combining unit, which houses combining optics, a thermally stabilized harmonic generation assembly, and dichroic separation optics. The resulting unit has great mechanical stability, allowing full benefit to be taken from the laser's exceptional pointing accuracy.

The Twins laser system is compact enough to be transported easily to allow off-site measurements to be carried out. The user-friendly character of Twins is enhanced by freedom from any external water source. For those who work in hot air environment the Twins B can be delivered with a water-to-water exchanger. Second harmonic generation is in a

type II KD*P crystal after combining the infrared beams in a polarizer. The two collinear output pulses have the same plane of polarization.

As an option, two SHG units may be used, with subsequent combination of two green beams, with output pulses with orthogonal polarization. In each case, the residual infrared radiation is separated by dichroic mirrors and safely dumped inside the unit.

Ease of Use

Each laser can be controlled via the built-in RS232 interface or by external TTL trigger signals.

A length of the pre-drilled optical bench is left free at the output end for the convenience of the user. This enables the installation of accessories such as an articulated beam delivery arm or additional third or fourth harmonic generator.

Pulsed delay generator

The time delay between the laser pulses can be controlled via the DPS01 twin-channel delay generator. It provides a very flexible means of triggering each flashlamp and Pockels cell. The delay is user-selectable from 1 μ s to 1s in 1 μ s steps. Time delays from 5-500 ns are achieved by using the variable output synchronization signals, available as standard from each laser.

Options and Accessories

Other harmonics, such as 355nm and 266nm or a manual attenuator are available as "plug and play" modules. Cylindrical focusing optics, telescopes and many other items are available on request.

The Twins series can be supplied with double pulse options, enabling up to four illuminating pulses to be used.

For applications requiring very high energy, lasers in Quantel's YG series provide over 1000mJ in each pulse at 532nm. The YG series is also available with line narrowing etalons or an injection seeder for holographic PIV and ESPI applications.

It can also pump a tuneable dye laser (Quantel's TDL90) to give access to a range of visible and UV wavelengths for combustion applications.

If requested, different layouts of the output beams can be designed. For example, a direct access to IR beams allows double pulse LIBS experiments.



End User and OEM...

As well as supplying for PIV to universities and other research institutions, Quantel works closely with some of the world's leading suppliers of complete PIV systems. These companies offer solutions that include the laser and the peripherals such as the imaging system and the computer and software needed to make measurements.

In addition to its line of standard products, Quantel has the capability to offer custom engineered multi-pulse laser solutions.

Specifications - Green laser systems

Model	Twins BSL 30	Twins BSL 50	Twins BSL 140	Twins	Twins BSL 200	Twins BSL 220	Twins B
Oscillator	Ultra 50	Ultra 100	CFR 200	Brilliant	CFR 300	CFR 400	Brilliant B
Wavelength (nm)	532	532	532	532	532	532	532
Repetition Rate (Hz)	15	15	15 / 30	10	15	15	10
Energy per pulse (mJ)	30	50	140 / 130	150	200	220	380
Energy stability (shot to shot % (rms))	+/- 6 (<2)	+/- 6 (<2)	+/- 3 (<1)	+/- 5 (1.6)	+/- 3 (<1)	+/- 3 (<1)	+/- 5 (1.6)
Pulse duration (ns)	7	7	8	4	8	7	5
Beam diameter (mm)	3	4	6	6	6	7	9
Beam divergence (mrad - full angle)	<6	<7	<4	<0.5	<4	<4.5	<0.5
Pointing stability (µrad)	<100	<100	<100	<50	<100	<100	<50
Jitter (ns)	+/- 2	+/- 2	+/- 2	+/- 0.5	+/- 2	+/- 2	+/- 0.5
Polarization	Horizontal	Horizontal	Horizontal	Vertical	Horizontal	Horizontal	Vertical
Operating temperature	10 - 30 °C	10 - 30 °C	10 - 30 °C	18 - 28 °C	10 - 30 °C	10 - 30 °C	18 - 28 °C
Power Supply	ICE 450	ICE 450	ICE 450	ICE 1000	ICE 450	ICE 450	ICE 1000

Specifications - Green & UV laser systems

Model	Twins BSL 30	Twins BSL 50	Twins BSL 140	Twins	Twins BSL 200	Twins BSL 220	Twins B
Wavelength (nm)			266	355 or 266	266		355 or 266
Energy, @266nm (mJ) Colinear with residual 532 nm			1 x 30	on request	1x50 / 2x30		on request
Energy, nominal @ 532nm residual (mJ) With 4 th harmonic switched off			2 x 110	on request	2 x 165		on request
Energy stability (shot to shot % (rms))			+/- 10 (3)	on request	+/- 10 (3)		on request
Beam divergence (mrad)			<3	on request	<3		on request
Polarization			Vertical	on request	Vertical		on request

Energy drift over 8 hours: <10%

Warm-up time for PIV alignment: <30mn

Beam profile: Flat in Near Field and >90% fit to Gaussian in Far Field

Nominal flashlamp lifetime: 50 million shots for BSL models, 30 million shots for Twins & Twins B

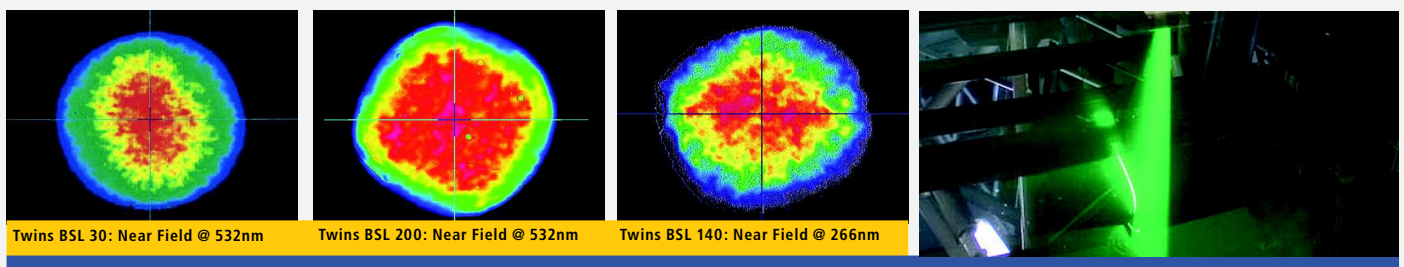
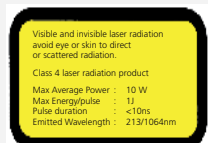

Twins BSL 30: Near Field @ 532nm

Twins BSL 200: Near Field @ 532nm

Twins BSL 140: Near Field @ 266nm

The dual oscillator systems cover a wide range of output energies. Information on higher repetition frequencies is available on request. All Twins BSL are powered with two ICE450's (Integrated Cooling and Electronics), Twins and Twins B are powered with two high power ICE1000's.

Twins BSL

All dimensions are in mm (inches)

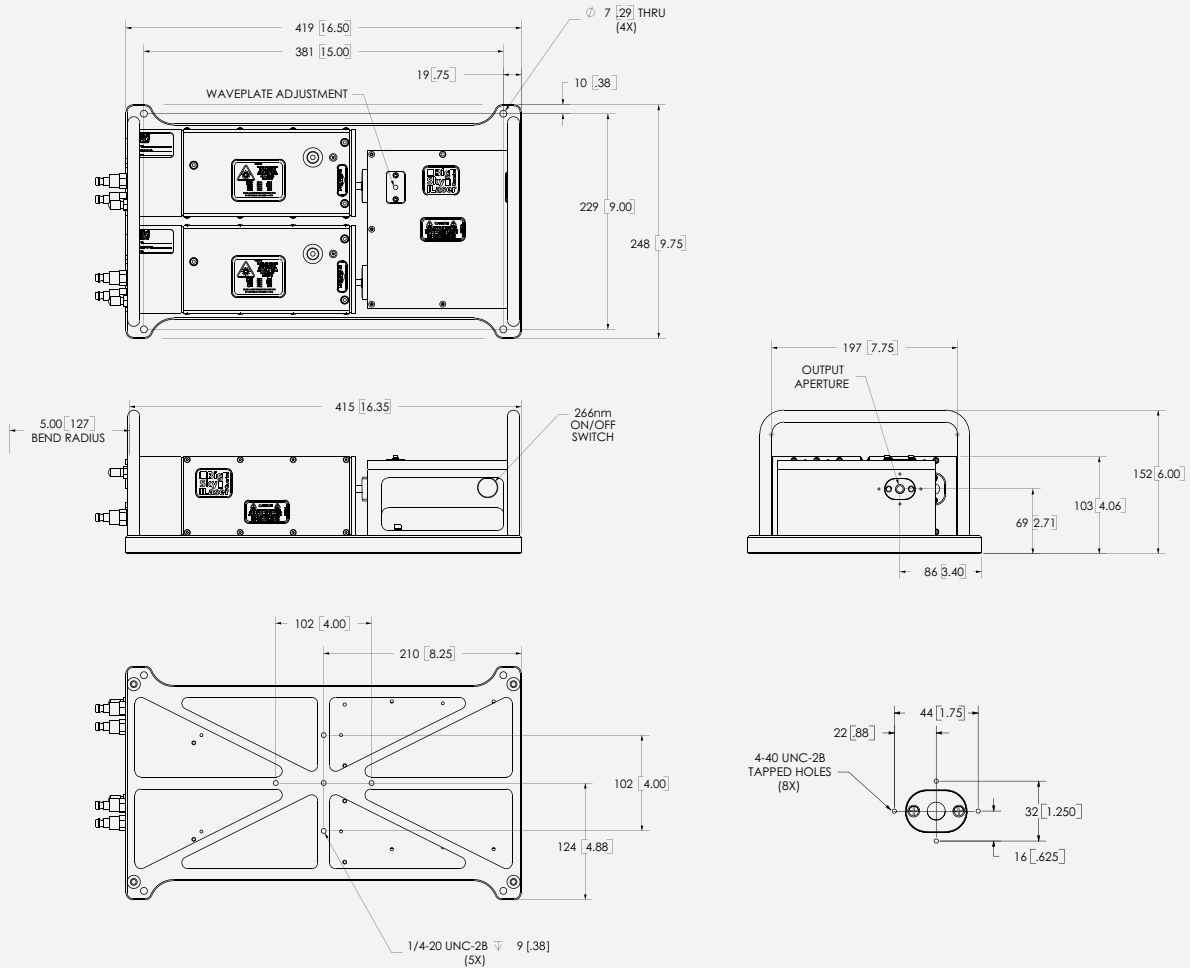

Twins & Twins B

All dimensions are in mm (inches)

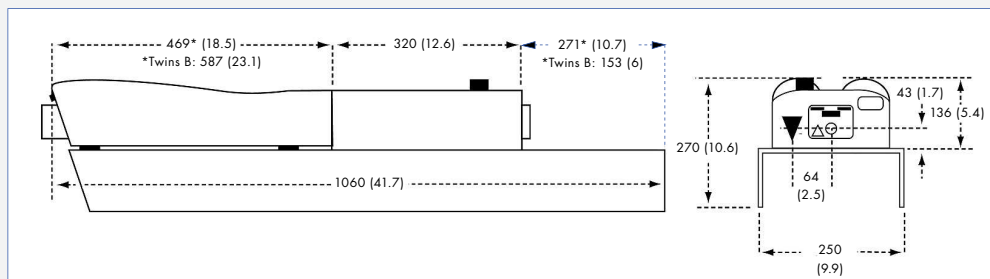

ICE 450
(HxLxW) 356x133x457 mm
(14x5.25x18 inches)
Weight: 13,2 kg (29 lbs)
Universal voltage 85/240V
Used with Twins BSL



ICE 1000
(HxLxW) 585x286x592 mm
(23x14x23 inches)
Weight: 50 kg (110 lbs)
Voltage 230V – 100, 115 & 200V on request
Used with Twins & Twins B



Quantel



Manufacturing Facilities



Quantel USA



Quantel
2 bis, Avenue du Pacifique - ZA de Courtaboeuf - B.P.23
91941 Les Ulis Cedex - France
Ph.: + 33 (0)1 69 29 17 00 - Fax : + 33 (0)1 69 29 17 29

Quantel-USA
601 Haggerty Lane
Bozeman, MT 59715 - 2001 - USA
Ph.: + 1 406 586 0131 - fax: + 1 406 586 2924

quantel@quantel.fr - www.quantel-laser.com