

960-0060 MEDIUM (width 50 mm) MOTORIZED TRANSLATION STAGES

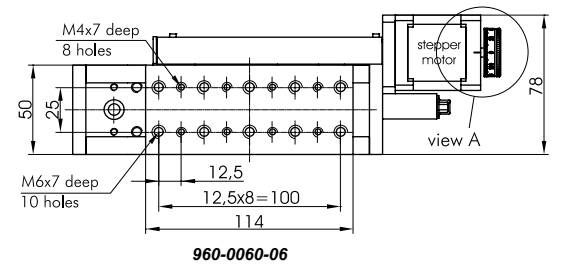
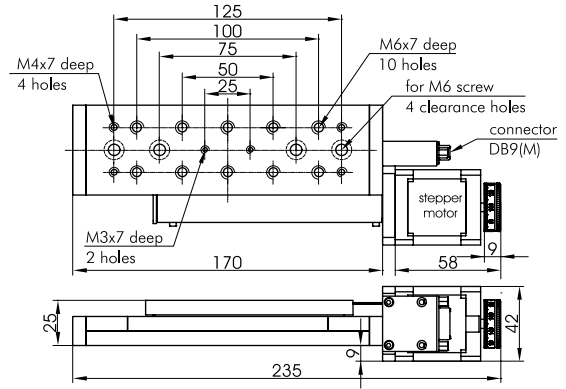
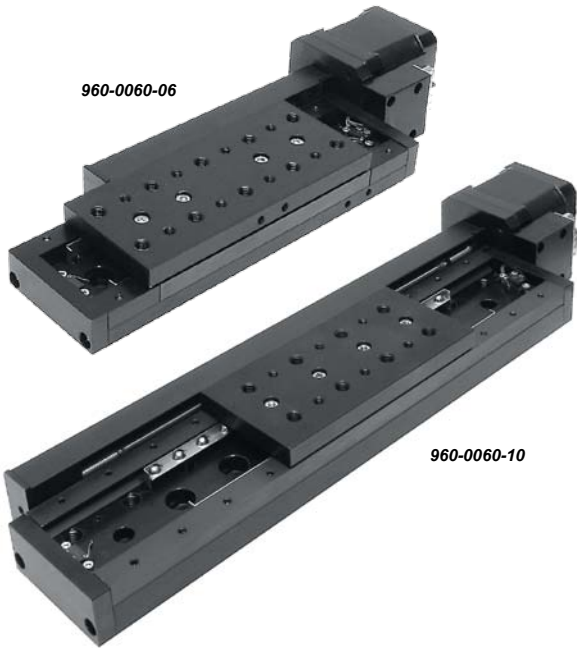

- Narrow (50 mm)
- Compact design
- High guide way accuracy
- Resolution 0.31 μm (1/8 step)
- Travel 50, 100, 150, 200 mm
- X-Y-Z configurations available

Vacuum Compatible Motorized Stages
960-0060V is available.
For product data sheets please visit
www.eksmaoptics.com

Motorized stages of higher speed
are available upon request.

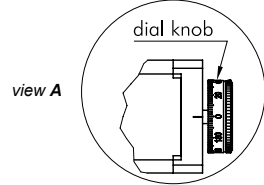
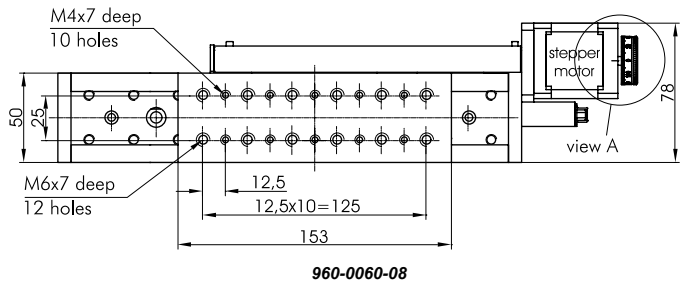
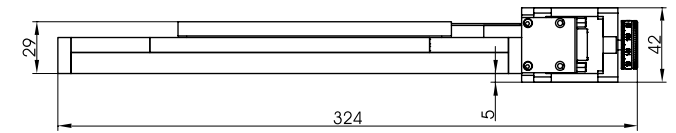
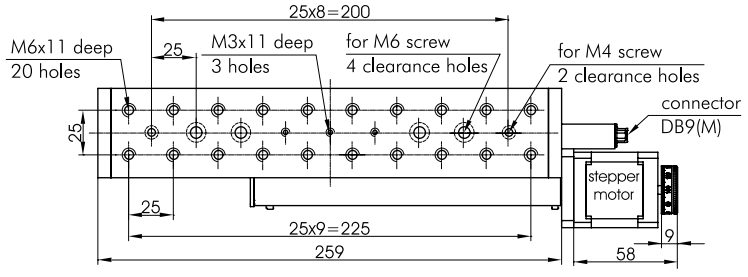

RECOMMENDED CONTROLLERS

980-0040-USB
see page 8.189

980-0030-RS232
see page 8.188

980-0060-USB
see page 8.191

OPTICAL TABLES
BRACKETS & RAILS
BASE MOUNTS & ACCESSORIES
OPTICAL MOUNTS
OPTICAL POSITIONERS
BASE POSITIONERS
TRANSLATION & ROTATION STAGES
ADJUSTMENT SCREWS
MOTORIZED POSITIONERS

OPTICAL
TABLES

BRACKETS &
RAILS

BASE MOUNTS &
ACCESSORIES

OPTICAL
MOUNTS

OPTICAL
POSITIONERS

BASE
POSITIONERS

TRANSLATION &
ROTATION STAGES

ADJUSTMENT
SCREWS

MOTORIZED
POSITIONERS



960-0060-06 xy

In XY configuration medium width stages stack directly using M6 screws.
For XYZ stacking optional brackets are available.

Angle Bracket 810-0160



Angle Bracket 810-0160 is used to transform "horizontal" translators into vertical ones.
See page 8.30 for details.

Base Plate 820-0136



Medium width stages have a motor protruding from the bottom. To place such stages on flat surfaces you need a base plate. It is designed for attaching translation stages 860-0060 and motorized translation stages 960-0060, 960-0080.

Complementary Products

Code	Page
810-0160	8.30

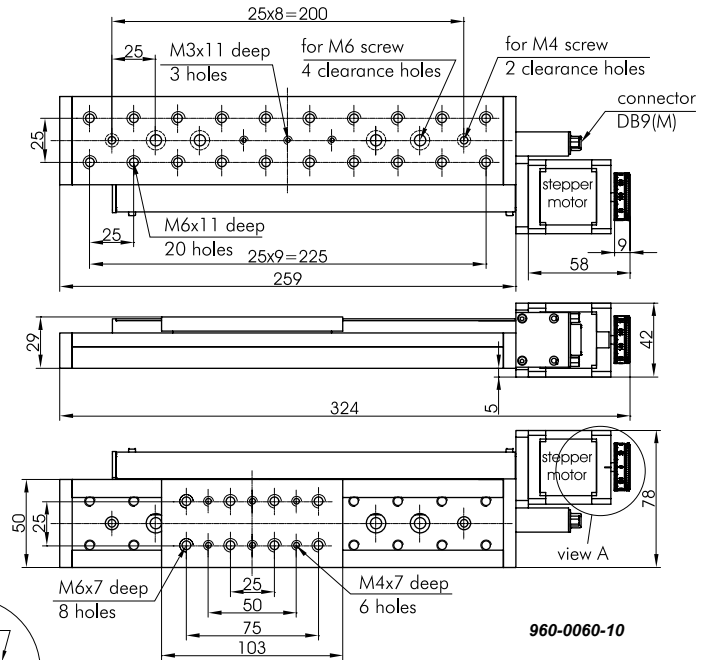

960-0060-08

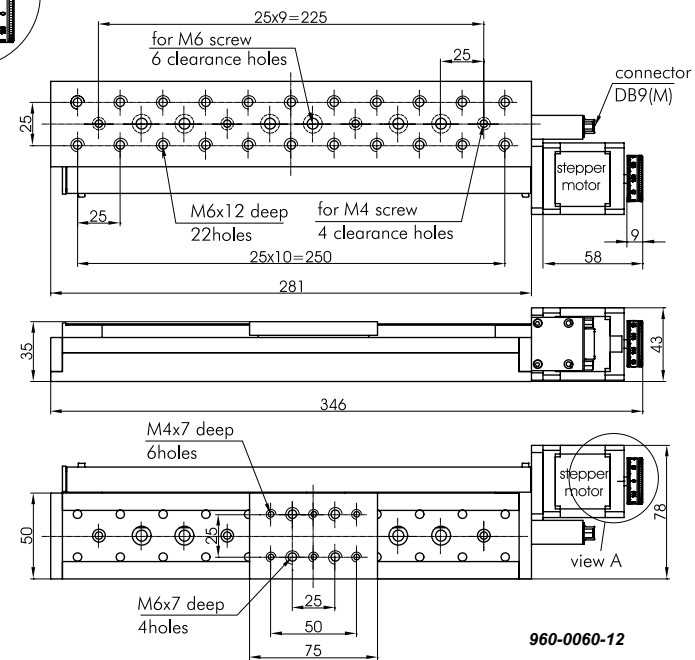
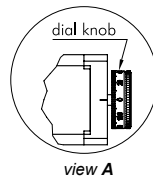

960-0060-12

SPECIFICATIONS

Model	960-0060-06	960-0060-08	960-0060-10	960-0060-12
Travel range, mm	50	100	150	200
Lead screw pitch, mm			0.5	
Resolution in full step*, µm			2.5	
Resolution in 1/8 step*, µm			0.31	
Max. speed*, mm/s			10	
Load capacity:				
horizontal, kg			8	
vertical, kg			3	
Motor connector			DB9(M)	
Stepper motor			4247	
Weight, kg	1	1.5	1.5	1.6
Assemblies:				
X-Y			directly	
Z			810-0160	
Mechanical end limit switches			2	
Switch polarity			pushed is closed	
Price, EUR	811	909	1139	1577

***Test condition:**
• 980-0030 controllers;
• Power supply – 36 V.