

PRO165LM Series

Mechanical Bearing, Linear Motor Stage

Improved second-generation design

Rugged mechanical construction

Direct-drive linear motor for ultra-precise motion

Ten models with travels from 100 mm to 1000 mm

Vacuum and cleanroom versions available

Available with ThermoComp™ for high-performance in changing environments

The PRO165LM is part of Aerotech's second-generation PRO-LM stage series with many improvements and added features. Enhanced positioning specifications, improved stiffness, and competitive pricing make the PRO165LM stage the ideal choice for both medium and high-performance production applications. The design is similar to the PRO115LM series, providing additional load capacity and stiffness with larger bearings and a wider cross-section.

Rugged Mechanical Construction

A long-life recirculating linear guide bearing system and a low-friction sealing solution make the PRO165LM an attractive solution for industrial applications such as laser machining. The basic external construction of the PRO165LM design provides protection from debris while the side-seals prevent dirt and particulates from entering the stage. The curved hard-cover design provides a natural shape that prevents excessive debris from collecting on the stage.

Precision Motion Performance

The PRO165LM series stages are optimized with high-precision, noncontact linear encoders that are protected from debris by the stage sealing system. Precision recirculating linear bearings along with machining and assembly craftsmanship enable excellent geometric performance specifications.

Incremental and absolute encoders are available as standard options and enable minimum incremental motion down to 5 nm and sub-micrometer repeatability.

PRO Series Gen II

Up to:
98% Higher Resolution
46% Better Repeatability
40% Reduction in Error Motions
33% Improved Accuracy

Available with
ThermoComp™



The PRO165LM-600 is one of 10 models in the PRO165LM series.

Accurate Positioning with ThermoComp

Temperature changes and thermal effects are some of the largest error sources in precision machines. All PRO series stages are available with Aerotech's ThermoComp feature, an embedded temperature compensation unit that guarantees accurate positioning in variable temperature environments. Using this feature protects your process from real-world conditions, even in extreme industrial settings.

Direct-Drive Linear Motor

Aerotech's high-power U-channel linear motors drive the PRO165LM. The ironlessforcer coil provides high force with zero cogging for super-smooth velocity and position control. This ironless design is ideal for applications requiring outstanding contour accuracy and smooth velocity profiling. As with all Aerotech linear motor stages, the linear motor has zero backlash, no windup, zero friction, and excellent dynamic responsiveness.

Design and Integration Flexibility

The PRO165LM is designed with many standard features and options that make the design incredibly flexible and allow it to be easily tailored to a specific application. The PRO165LM is available in 10 different models with travels ranging from 100 mm to 1000 mm and speeds up to 2 m/s. Configurable cable management solutions are available for single and multi-axis systems as standard options.

Standard mounting holes for both English and metric optical tables are present in all travels. The tabletop is available with both English and metric mounting patterns and can be ordered with brush attachments to clear any debris that may collect on the stage hard cover. Tabletops with hole patterns that allow the direct attachment of several Aerotech rotary stages are also available.

The PRO165LM series is also available with cleanroom preparation and vacuum versions.

PRO165LM Series SPECIFICATIONS

Mechanical Specifications		PRO165LM									
Travel		100	150	200	250	300	400	500	600	800	1000
Accuracy ⁽¹⁾	Standard	±4 µm	±6 µm	±8 µm	±9 µm	±10 µm	±12 µm	±14 µm	±15.5 µm	±17 µm	±18 µm
	Calibrated	±1 µm	±1 µm	±1.5 µm	±1.5 µm	±1.5 µm	±1.5 µm	±2 µm	±2 µm	±2 µm	±2 µm
Resolution (Min. Incremental Motion)	5 nm (-E1 Encoder), 10 nm (-E3 Encoder)										
Bidirectional Repeatability ⁽¹⁾		±0.4 µm	±0.4 µm	±0.5 µm	±0.5 µm	±0.5 µm	±0.5 µm	±0.5 µm	±0.5 µm	±0.5 µm	±0.5 µm
Horizontal Straightness ⁽¹⁾		±2.5 µm	±3 µm	±4 µm	±5 µm	±6 µm	±8 µm	±9 µm	±10 µm	±12 µm	±14 µm
Vertical Straightness ⁽¹⁾		±2.5 µm	±3 µm	±4 µm	±5 µm	±6 µm	±8 µm	±9 µm	±10 µm	±12 µm	±14 µm
Pitch		29 µrad (6 arc sec)	29 µrad (6 arc sec)	40 µrad (8.2 arc sec)	46 µrad (9.5 arc sec)	58 µrad (12 arc sec)	70 µrad (14.4 arc sec)	80 µrad (16.5 arc sec)	90 µrad (18.6 arc sec)	100 µrad (20.6 arc sec)	120 µrad (24.7 arc sec)
Roll		29 µrad (6 arc sec)	29 µrad (6 arc sec)	40 µrad (8.2 arc sec)	46 µrad (9.5 arc sec)	58 µrad (12 arc sec)	70 µrad (14.4 arc sec)	80 µrad (16.5 arc sec)	90 µrad (18.6 arc sec)	100 µrad (20.6 arc sec)	120 µrad (24.7 arc sec)
Yaw		29 µrad (6 arc sec)	29 µrad (6 arc sec)	40 µrad (8.2 arc sec)	46 µrad (9.5 arc sec)	58 µrad (12 arc sec)	70 µrad (14.4 arc sec)	80 µrad (16.5 arc sec)	90 µrad (18.6 arc sec)	100 µrad (20.6 arc sec)	120 µrad (24.7 arc sec)
Maximum Speed ⁽²⁾	2 m/s										
Maximum Acceleration ⁽²⁾	3 g										
Maximum Force, Continuous	77.7 N										
Load Capacity ⁽³⁾	Horizontal	45 kg									
	Side	45 kg									
Moving Mass	2.6 kg										
Stage Mass		8.2 kg	9.1 kg	9.9 kg	10.7 kg	11.6 kg	13.3 kg	14.9 kg	16.6 kg	20.0 kg	23.3 kg
Material	Anodized Aluminum										
MTBF (Mean Time Between Failure)	20,000 Hours										

Notes:

1. Certified with -PL1 option.
2. Requires the selection of an appropriate amplifier with sufficient voltage and current.
3. Axis-orientation for on-axis loading is listed.
4. Specifications are for single-axis systems measured 25 mm above the tabletop. Performance of multi-axis systems is payload and workpoint dependent. Contact factory for multi-axis applications.

Electrical Specifications	
Drive System	Brushless Linear Servomotor
Feedback	Noncontact Encoder Incremental – 1 Vpp and TTL (0.1 µm) Output Absolute – EnDat 2.2
Maximum Bus Voltage	320 VDC
Limit Switches	5 V, Normally-Closed
Home Switch	Near Center

Recommended Controller		
Multi-Axis	A3200	Ndrive HLe/Ndrive CP/Ndrive HPe/Npaq
	Ensemble	Ensemble HLe/Ensemble CP/Ensemble HPe
Single Axis	Soloist	Soloist CP/Soloist HPe

PRO165LM Series SPECIFICATIONS

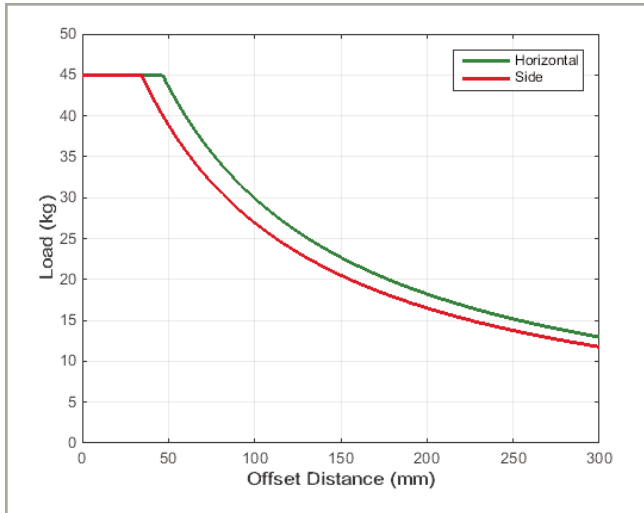

Cantilevered load capability of the PRO165LM.

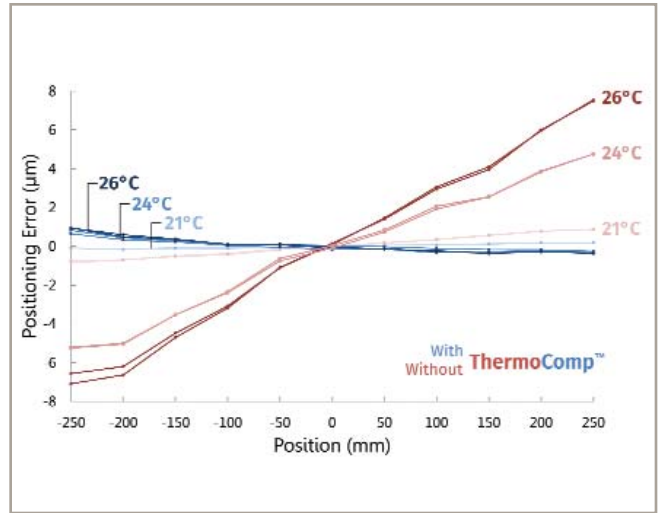

Measurement data showing successful compensation of thermal related positioning errors at several temperatures using the ThermoComp feature. Results are typical of stage performance with and without ThermoComp.

PRO165LM Series DIMENSIONS

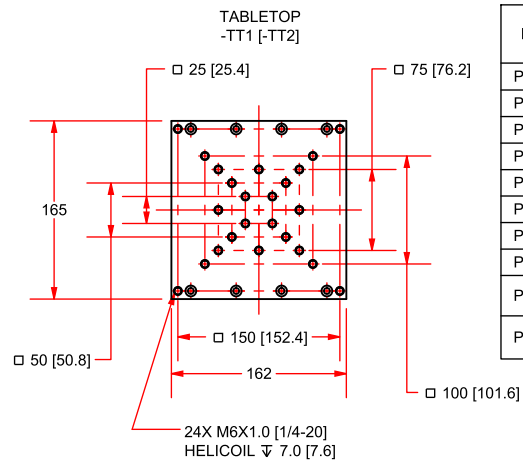
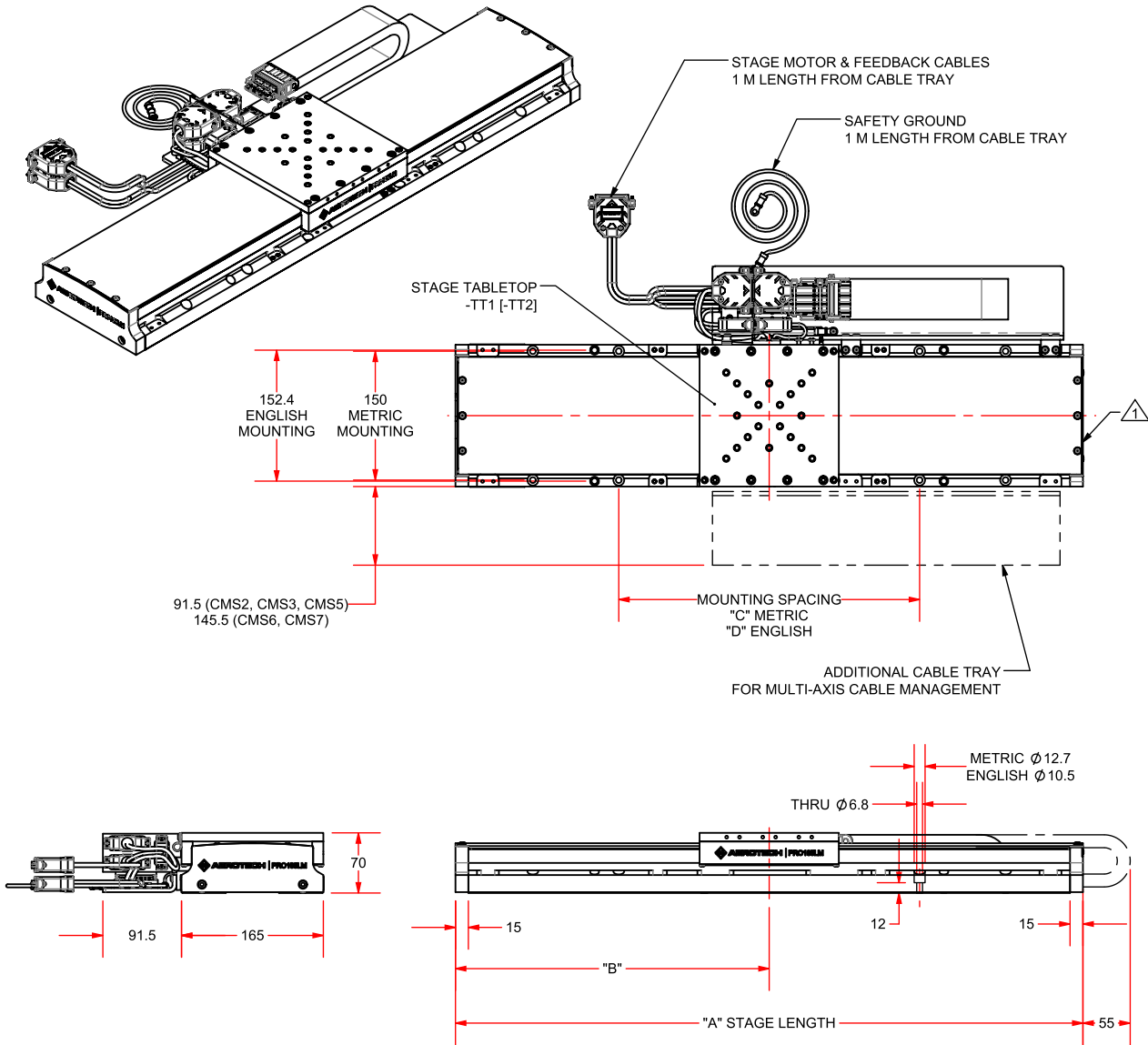

BASIC MODEL	NOMINAL TRAVEL	ELEC LIMIT TRAVEL	MECH LIMIT TRAVEL	A	B	C	D
PRO165LM-0100	100	102-108	116	330	165	150	152.4
PRO165LM-0150	150	152-158	166	380	190	150	152.4
PRO165LM-0200	200	202-208	216	430	215	150, 350	152.4
PRO165LM-0250	250	252-258	266	480	240	150, 350	152.4
PRO165LM-0300	300	302-308	316	530	265	150, 350	152.4, 406.4
PRO165LM-0400	400	402-408	416	630	315	150, 350, 550	152.4, 406.4
PRO165LM-0500	500	502-508	516	730	365	150, 350, 550	152.4, 406.4
PRO165LM-0600	600	602-608	616	830	415	150, 350, 550, 750	152.4, 406.4, 660.4
PRO165LM-0800	800	802-808	816	1030	515	150, 350, 550, 750, 950	152.4, 406.4, 711.2
PRO165LM-1000	1000	1002-1008	1016	1230	615	150, 350, 550, 750, 950, 1150	152.4, 406.4, 711.2, 1016

NOTES:

1. ∇ M5X0.8 FOR CUSTOMER-INSTALLED AIR PURGE FITTING.

2. DIMENSIONS: MILLIMETERS.

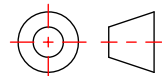

PRO165LM Series Accessory Tabletop DIMENSIONS

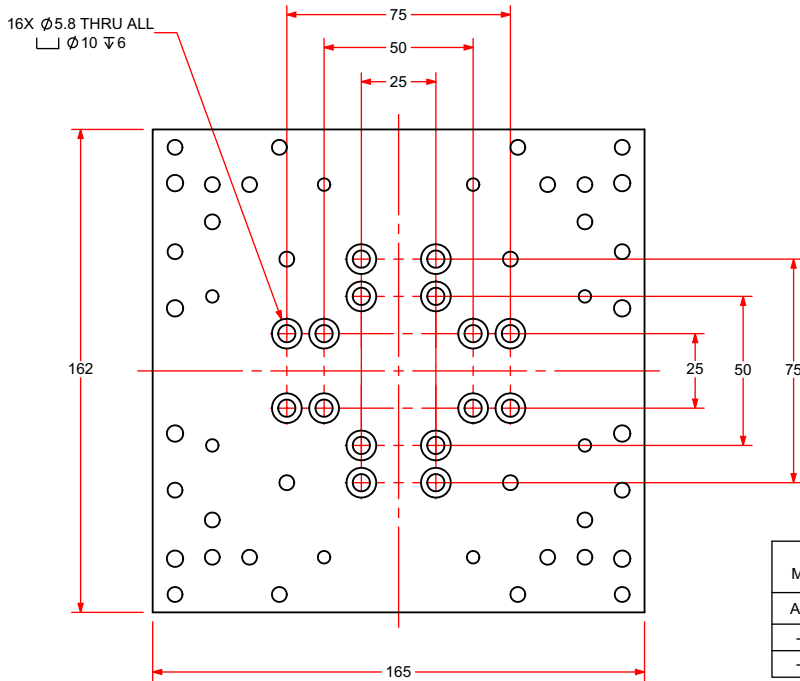
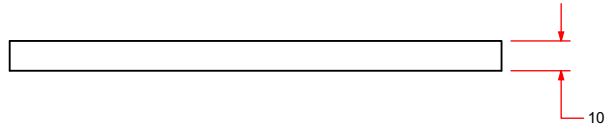
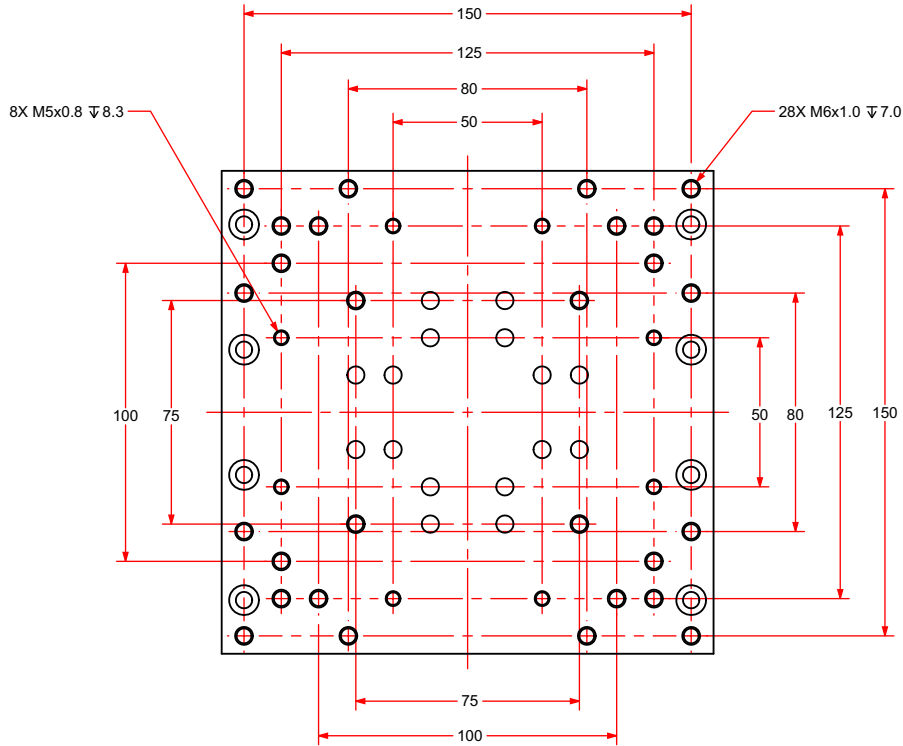

-TT3 MOUNTS THE FOLLOWING		
ADRS	ADRT	AGR
-100		75
-150	-150	100*

*SIDE MOUNT NOT AVAILABLE

DIMENSIONS: MILLIMETERS

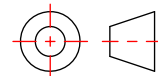

PRO165LM Series Cable Management (-CMS0) DIMENSIONS

PRO115LM/PRO165LM -CMS0

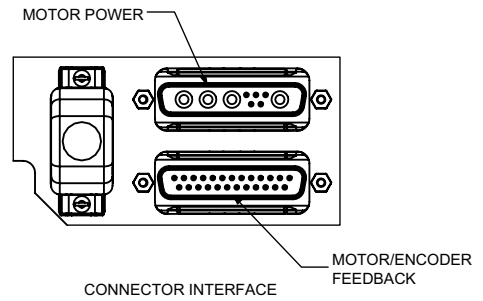
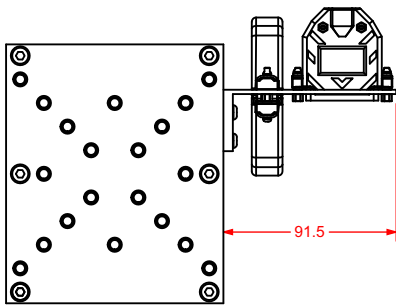

PRO190LM -CMS0

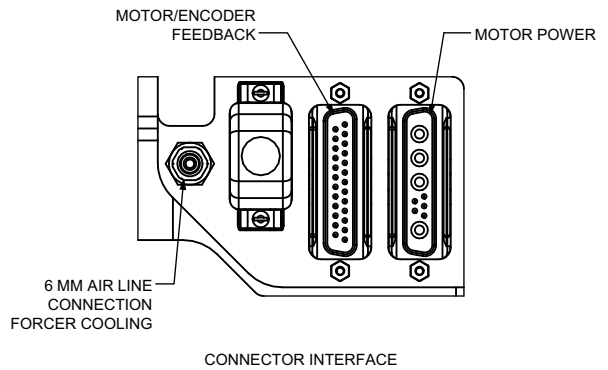
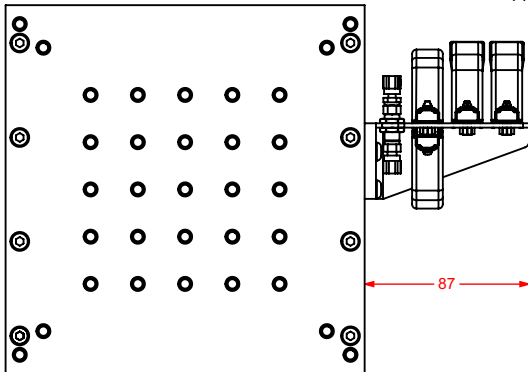

PRO225LM/PRO280LM/PRO560LM -CMS0

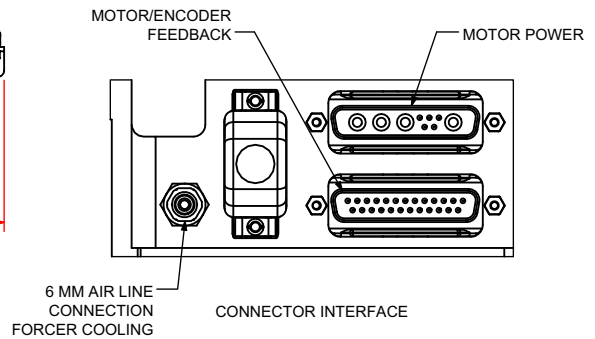
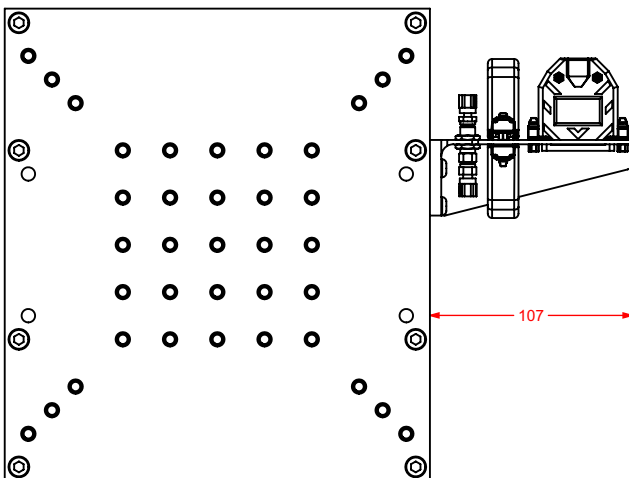

DIMENSIONS: MILLIMETERS

PRO165LM Series ORDERING INFORMATION**Travel (Required)**

-0100	100 mm travel stage
-0150	150 mm travel stage
-0200	200 mm travel stage
-0250	250 mm travel stage
-0300	300 mm travel stage
-0400	400 mm travel stage
-0500	500 mm travel stage
-0600	600 mm travel stage
-0800	800 mm travel stage
-1000	1000 mm travel stage

Mounting Orientation (Required)

	Normal mounting orientation
-MT1	Side-mounted or vertical orientation
-MT2	Inverted mounting orientation

Tabletop (Required)

-TT1	Tabletop with metric dimension mounting
-TT2	Tabletop with English dimension mounting
-TT3	Accessory tabletop with mounting for select rotary stages
-TT4	Tabletop with metric dimension mounting and wiper brushes
-TT5	Tabletop with English dimension mounting and wiper brushes
-TT6	Accessory tabletop with mounting for select rotary stages and wipers

NOTE: -TT1 or -TT4 tabletop option required for lower axis of XY.

Feedback (Required)

-E1	Incremental linear encoder, 1 Vpp
-E2	Incremental linear encoder, 0.1 μ m digital TTL output
-E3	Absolute linear encoder, EnDat 2.2

Cable Management (Required)

-CMS0	No external CMS, motor/feedback connector bracket on carriage
-CMS1	External CMS for single axis
-CMS2	External CMS for lower-axis of two-axis PRO (XY) assembly
-CMS3	External CMS for lower-axis of two-axis (XZ or XT) assembly
-CMS4	External CMS for upper-axis of two-axis PRO (XY) assembly
-CMS5	External CMS for upper-axis of two-axis (YZ or YT) assembly
-CMS6	External CMS for lower-axis of three-axis (XYZ or XYT) assembly
-CMS7	External CMS for lower-axis of three-axis (XZT) assembly

Lifting Hardware (Optional)

-LF	Lifting hardware
-----	------------------

NOTE: Lifting option only available on travels 400 mm and greater. Lifting should never be ordered on the upper-axis of an XY set (only order on lower-axis).

ThermoComp (Optional)

-TCMP	ThermoComp integrated thermal compensation, single or lower axis
-------	--

NOTE: An A3200 controller must be used with the -TCMP option

Metrology (Required)

-PL0	No metrology performance plots
-PL1	Metrology, uncalibrated with performance plots
-PL2	Metrology, calibrated (HALAR) with performance plots

PRO165LM Series ORDERING INFORMATION

Integration (Required)

Aerotech offers both standard and custom integration services to help you get your system fully operational as quickly as possible. The following standard integration options are available for this system. Please consult Aerotech if you are unsure what level of integration is required, or if you desire custom integration support with your system.

-TAS	Integration - Test as system Testing, integration, and documentation of a group of components as a complete system that will be used together (ex: drive, controller, and stage). This includes parameter file generation, system tuning, and documentation of the system configuration.
-TAC	Integration - Test as components Testing and integration of individual items as discrete components. This is typically used for spare parts, replacement parts, or items that will not be used or shipped together (ex: stage only). These components may or may not be part of a larger system.

Accessories (to be ordered as a separate line item)

ALIGN-NPA	Non-precision XY assembly
ALIGN-NPAZ	Non-precision XZ or YZ assembly
ALIGN-PA10	XY assembly; 10 arc sec orthogonality. Alignment to within 7 microns orthogonality for short travel stages.
ALIGN-PA10Z	XZ or YZ assembly with L-bracket; 10 arc second orthogonality. Alignment to within 10 microns orthogonality for short travel stages.
ALIGN-PA5	XY assembly; 5 arc sec orthogonality. Alignment to within 3 microns orthogonality for short travel stages.
ALIGN-PA5Z	XZ or YZ assembly with L-bracket; 5 arc second orthogonality. Alignment to within 5 microns orthogonality for short travel stages.