

# ANT130L Series

## Single-Axis Linear Direct-Drive Nanopositioning Stages

Nanometer-level performance in a large travel format

High resolution (1 nm), repeatability (75 nm), and accuracy (250 nm)

In-position stability of <1 nm

Anti-creep crossed-roller bearings

High dynamic performance

Large selection – 8 models in travel and accuracy

## nano Motion Technology

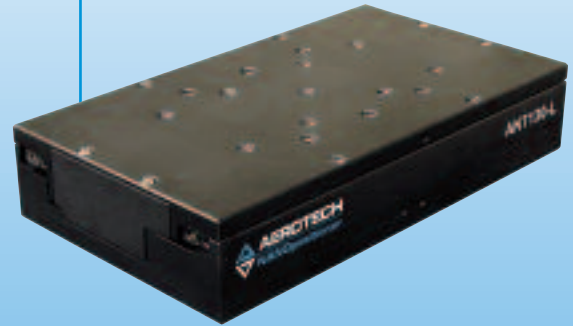

### Introduction

The ANT130L series stages offer nanometer-level performance in travels up to 160 mm. With its low profile and outstanding performance characteristics, the ANT130L is the ultimate solution for high-accuracy alignment, inspection, positioning, and measurement stations.

### Noncontact Direct-Drive

The linear motor drive also offers the advantage of higher speeds and accelerations. The compact yet powerful linear motor drives the ANT130L to a peak unloaded acceleration of 1 g and a maximum velocity of 350 mm/s. The result is a high-accuracy device with outstanding throughput that significantly outperforms comparable high-accuracy screw-driven or other stages in its class.

### Outstanding Resolution

For alignment applications, outstanding step-to-step resolution is critical. The ANT130L meets this demand with an incremental step size of 1 nm when coupled with Aerotech drives and controls. The direct-drive linear motor allows the ANT130L to make precise, small resolution steps. This is particularly important in alignment applications where step accuracy is critical.

### Designed for Long Life

Like all stages in the Aerotech product family, the ANT130-L was designed for outstanding long-term performance. Both the linear motor and linear encoder are noncontact devices, which means they not only exhibit long-life but are totally maintenance free.

### Precision Alignment

ANT130-L series stages are easily configured as XY assemblies. Options include precision orthogonality alignment to 5 arc seconds and vertical axis solutions.

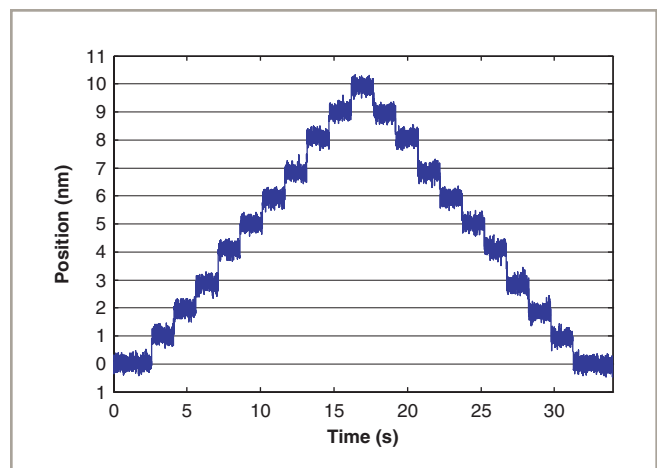

*ANT130L 1 nm step plot with 100 Hz filter. These stages offer best-in-class resolution and exceptional in-position stability for large travels.*

## ANT130L Series SPECIFICATIONS

Mechanical Specifications		ANT130L-035	ANT130L-060
Travel		35 mm	60 mm
Accuracy <sup>(1)</sup>	Base	±2 µm (±80 µin)	±2 µm (±80 µin)
	PLUS	±250 nm (±10 µin)	±250 nm (±10 µin)
Resolution (Minimum Incremental Motion)		1 nm (0.04 µin)	1 nm (0.04 µin)
Repeatability (Bi-Directional) <sup>(1)</sup>	Base	±100 nm (±4 µin)	±100 nm (±4 µin)
	PLUS	±75 nm (±3 µin)	±75 nm (±3 µin)
Repeatability (Uni-Directional)		±25 nm (±1 µin)	±25 nm (±1 µin)
Straightness <sup>(1)</sup>		±1.0 µm (±40 µin)	±1.0 µm (±40 µin)
Flatness <sup>(1)</sup>		±1.0 µm (±40 µin)	±1.0 µm (±40 µin)
Pitch		10 arc sec	10 arc sec
Roll		10 arc sec	10 arc sec
Yaw		5 arc sec	5 arc sec
Maximum Speed		350 mm/s (14 in/s)	350 mm/s (14 in/s)
Maximum Acceleration		1 g - 10 m/s <sup>2</sup> (No Load)	1 g - 10 m/s <sup>2</sup> (No Load)
Speed Stability		See graph for typical performance	
Settling Time		See graph for typical performance	
In-Position Stability <sup>(2)</sup>		<1 nm (<0.04 µin)	<1 nm (<0.04 µin)
Maximum Force (Continuous)		23 N	23 N
Load Capacity <sup>(3)</sup>	Horizontal	12.0 kg (26.5 lb)	12.0 kg (26.5 lb)
	Side	10 kg (22 lb)	10 kg (22 lb)
Moving Mass		1.2 kg (2.6 lb)	1.4 kg (3.1 lb)
Stage Mass		2.1 kg (4.6 lb)	2.5 kg (5.5 lb)

## Notes:

1. Certified with each stage.

2. In-Position Jitter listing is 3 sigma value.

3. Axis orientation for on-axis loading is listed.

• Specifications are for single-axis systems measured 25 mm above the tabletop. Performance of combined multi-axis systems is payload and workpoint dependent. Consult factory for multi-axis or non-standard applications.

• -PLUS requires the use of an Aerotech controller

## ANT130L Series SPECIFICATIONS

Mechanical Specifications		ANT130L-110	ANT130L-160
Travel		110 mm	160 mm
Accuracy <sup>(1)</sup>	Base	±3 µm (±120 µin)	±4 µm (±160 µin)
	PLUS	±300 nm (±12 µin)	±300 nm (±12 µin)
Resolution (Minimum Incremental Motion)		1 nm (0.04 µin)	1 nm (0.04 µin)
Repeatability (Bi-Directional) <sup>(1)</sup>	Base	±100 nm (±4 µin)	±100 nm (±4 µin)
	PLUS	±75 nm (±3 µin)	±75 nm (±3 µin)
Repeatability (Uni-Directional)		±25 nm (±1 µin)	±25 nm (±1 µin)
Straightness <sup>(1)</sup>		±1.0 µm (±40 µin)	±1.5 µm (±60 µin)
Flatness <sup>(1)</sup>		±1.0 µm (±40 µin)	±1.5 µm (±60 µin)
Pitch		10 arc sec	10 arc sec
Roll		10 arc sec	10 arc sec
Yaw		5 arc sec	5 arc sec
Maximum Speed		350 mm/s (14 in/s)	350 mm/s (14 in/s)
Maximum Acceleration		1 g - 10 m/s <sup>2</sup> (No Load)	1 g - 10 m/s <sup>2</sup> (No Load)
Speed Stability		See graph for typical performance	
Settling Time		See graph for typical performance	
In-Position Stability <sup>(2)</sup>		<1 nm (<0.04 µin)	<1 nm (<0.04 µin)
Maximum Force (Continuous)		23 N	23 N
Load Capacity <sup>(3)</sup>	Horizontal	12.0 kg (26.5 lb)	12.0 kg (26.5 lb)
	Side	10 kg (22 lb)	10 kg (22 lb)
Moving Mass		1.9 kg (4.2 lb)	2.3 kg (5.1 lb)
Stage Mass		3.3 kg (7.3 lb)	3.9 kg (8.6 lb)

Notes:

1. Certified with each stage.

2. In-Position Jitter listing is 3 sigma value.

3. Axis orientation for on-axis loading is listed.

\* Specifications are for single-axis systems measured 25 mm above the tabletop. Performance of combined multi-axis systems is payload and workpoint dependent. Consult factory for multi-axis or non-standard applications.

• -PLUS requires the use of an Aerotech controller

Electrical Specifications	ANT130L
Drive System	Brushless Linear Servomotor
Feedback	Noncontact Linear Encoder
Maximum Bus Voltage	320 VDC (-4DU-25DU), 80 VDC (-25DU)
Limit Switches	5 V, Normally Closed
Home Switch	Near Center

Recommended Controller		ANT130L
Multi-Axis	A3200	Npaq-MXR Npaq MR-MXH Ndrive ML-MXH
	Ensemble	Npaq-MXR Npaq MR-MXH Ndrive ML-MXH
Single Axis	Soloist	Soloist ML-MXH

Note:

1. Linear amplifiers are required to achieve the listed specifications. Other options are available.

Note: To ensure the achievement and repeatability of specifications over an extended period of time, environmental temperature must be controlled to within 0.25°C/24 hours. If this is not possible, alternate products are available. Please consult Aerotech Application Engineering for more information.

## ANT130L Series PERFORMANCE

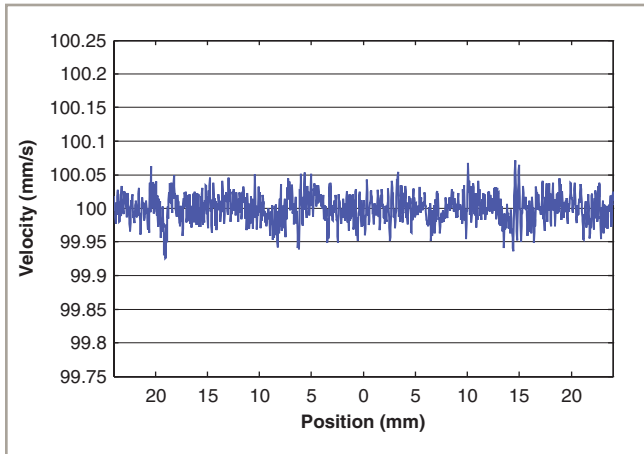

*ANT130L-060 PLUS velocity performance at 100 mm/s and 1 kg payload. Excellent speed stability is another feature of the ANT series stages.*

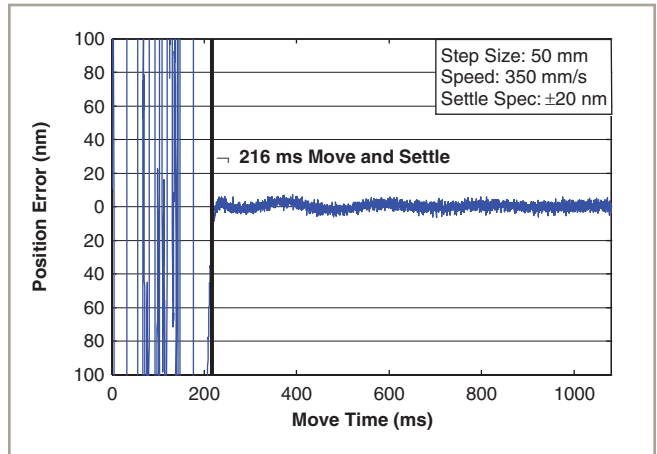

*ANT130L-060 PLUS step and settle performance with 1 kg payload. Outstanding settling time enhances throughput of most applications.*

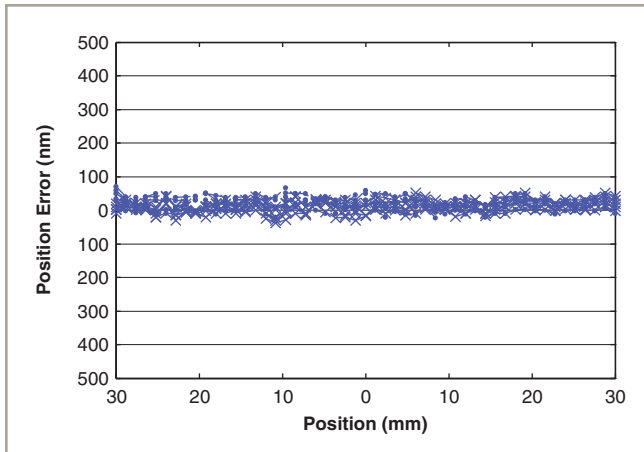

*ANT130L-060 PLUS accuracy and repeatability, five runs, bi-directional over an extended period of time shows the high level of system accuracy and repeatability.*

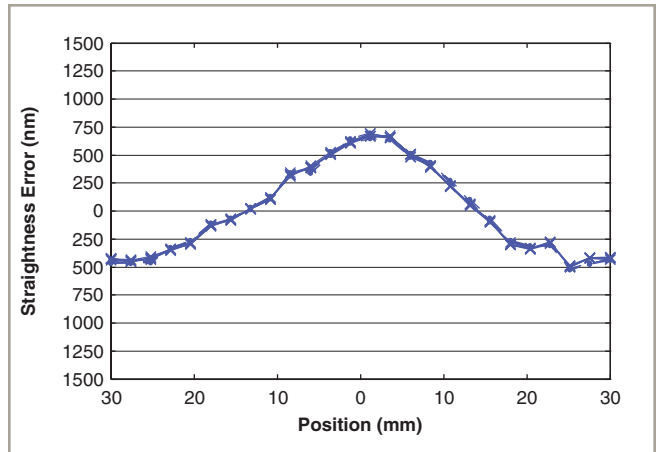

*ANT130L-060 PLUS straightness error, bi-directional. Exceptional and highly repeatable performance is assured with minimal straightness error.*

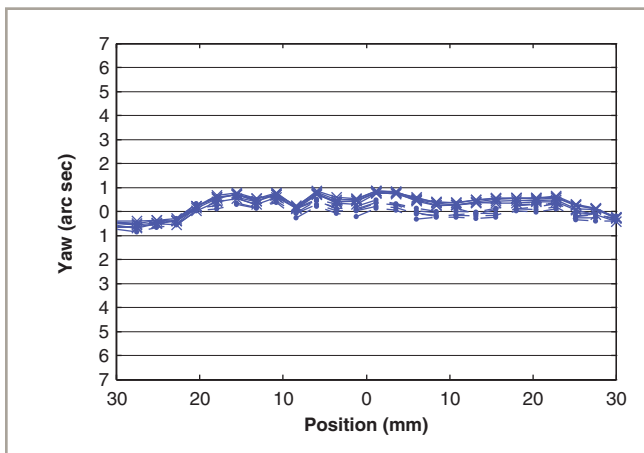

*ANT130L-060 PLUS yaw, five runs, bi-directional. Highly repeatable, minimal yaw error enhances system positioning accuracy.*

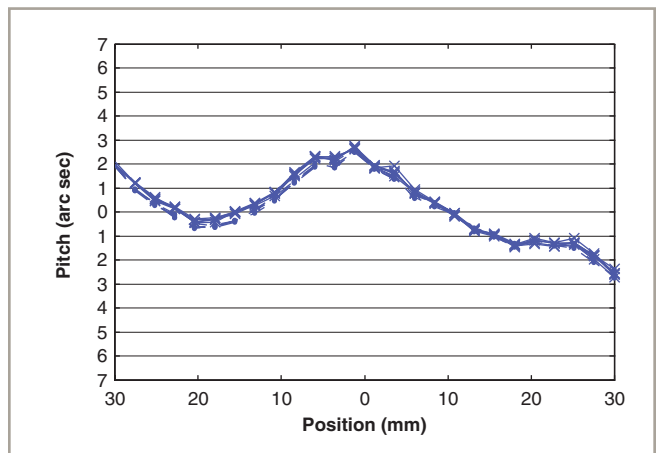

*ANT130L-060 PLUS pitch, five runs, bi-directional. Excellent repeatability/accuracy contribute to improved processing.*

# ANT130L Series DIMENSIONS

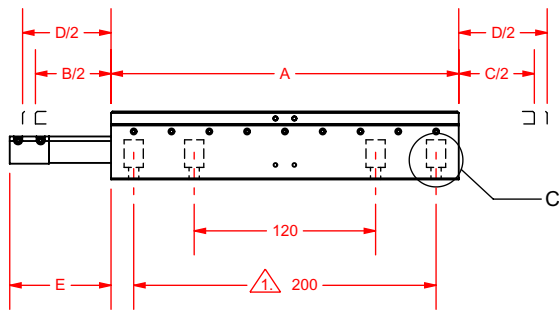
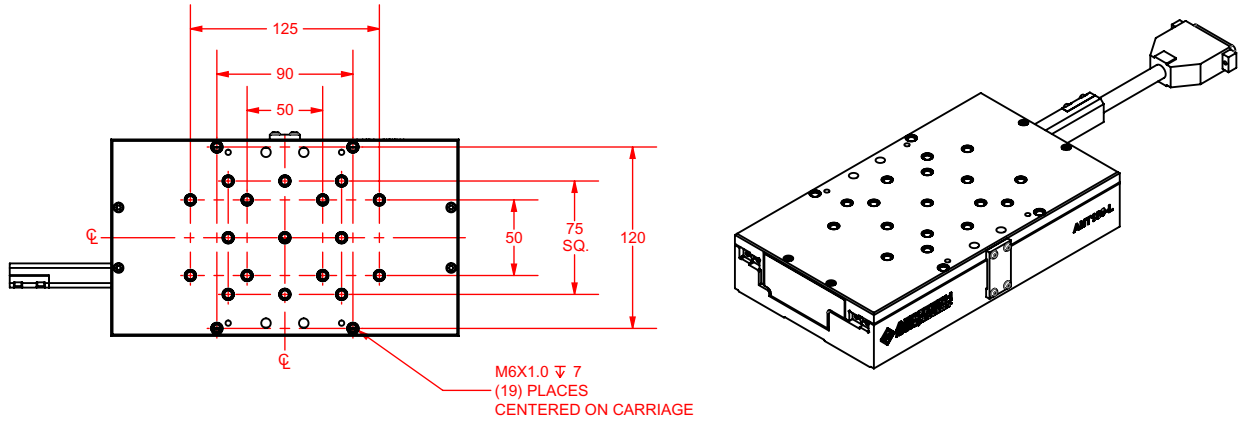

$\triangle$  ANT130L-110 AND ANT130L-160 ONLY

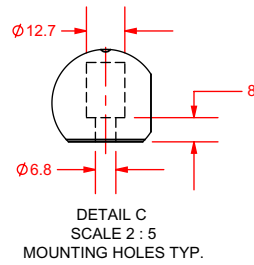
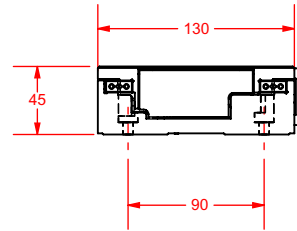

TRAVEL OPTION	A = STAGE LENGTH	B = NOMINAL TRAVEL	C = LIMIT TRAVEL	D = HARDSTOP TRAVEL	E
-035	155	35	41	50	27
-060	180	60	66	75	42
-110	230	110	116	125	67
-160	280	160	166	175	92

# ANT130-L Mounting Plate DIMENSIONS

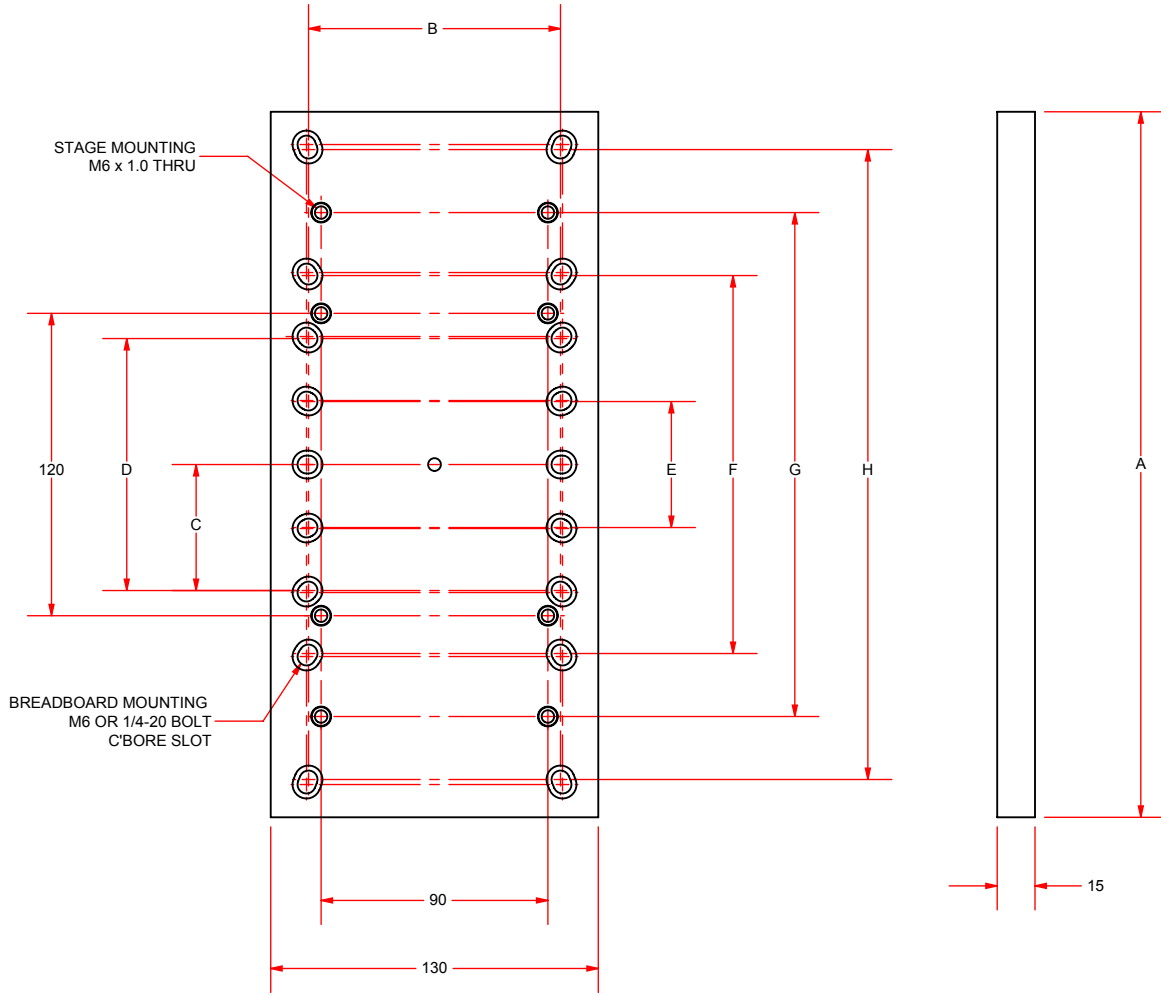

OPTION	LENGTH		MOUNTING					
	A	B	C	D	E	F	G	H
MP-ANT130-095	155	100[4.0]	50[2.0]	100[4.0]	--	--	--	--
MP-ANT130-060	180	100[4.0]	--	--	50[2.0]	150[6.0]	--	--
MP-ANT130-110	230	100[4.0]	--	--	50[2.0]	150[6.0]	200	--
MP-ANT130-160	280	100[4.0]	--	--	50[2.0]	150[6.0]	200	250[10.0]

DIMENSIONS: MILLIMETERS

## ANT130-L Series ORDERING INFORMATION

### Travel (Required)

-035	35 mm travel
-060	60 mm travel
-110	110 mm travel
-160	160 mm travel

### Connectors (Required)

-CN1	Single 25-pin D connector, 25DU
-CN2	Two connectors, 4-pin HPD and 25-pin D, 4DU-25DU

Note: CN1 option not valid for systems using bus voltages greater than 80 V

### Mounting Plate (Optional)

-MP	Mounting plate
-----	----------------

### Performance Grade (Required)

-PL1	Base performance
-PL2	High-accuracy performance, PLUS

### Integration (Required)

Aerotech offers both standard and custom integration services to help you get your system fully operational as quickly as possible. The following standard integration options are available for this system. Please consult Aerotech if you are unsure what level of integration is required, or if you desire custom integration support with your system.

-TAS	<p><b>Integration - Test as system</b></p> <p>Testing, integration, and documentation of a group of components as a complete system that will be used together (ex: drive, controller, and stage). This includes parameter file generation, system tuning, and documentation of the system configuration.</p>
-TAC	<p><b>Integration - Test as components</b></p> <p>Testing and integration of individual items as discrete components. This is typically used for spare parts, replacement parts, or items that will not be used or shipped together (ex: stage only). These components may or may not be part of a larger system.</p>